



THE POWER OF **CONNECTED**

Product Inspection Guide

Harness	1-6
Lanyards	
- Shock Absorbing.....	7-10
- Rope.....	11-15
- Web.....	16-19
- Wire Rope.....	20-22
Shock Absorbers	23-25
Synthetic Rope	
- Twisted Rope.....	26-30
- Braided Rope.....	30-33
- Kernmantel Rope.....	34-37
- Polysteel.....	38-41
Wire Rope Lifelines	42-44
Fall Limiters	
- Retractable Lanyard.....	45-57
- Self Retracting Lifeline...	58-64

Harness Inspection Guidelines

Webbing

Grasp the webbing with your hands and bend the webbing, checking both sides. This creates surface tension making damaged fibers or cuts easier to see. Webbing damage may not show up through a sight (visual) inspection only – manual (touch) the harness is equally important.

Visual and Touch Inspection

✓ Pass

✗ Fail Criteria

- ✗ Cuts, nicks or tears
- ✗ Broken fibers/cracks
- ✗ Overall deterioration
- ✗ Modifications by user
- ✗ Fraying/Abrasions
- ✗ ✓ Discoloration of material Dependant on cause of discoloration
- ✗ Hard or shiny spots Indicates heat damage
- ✗ Webbing thickness uneven Indicates possible fall
- ✓ Mildew Clean harness
- ✗ Missing Straps
- ✗ Undue Stretching Indicates possible fall
- ✗ Burnt, charred or melted fibers Indicates heat damage
- ✗ ✓ Material marked w/permanent marker Check w/manufacturer
- ✗ Excessive hardness or brittleness Indicates heat or uv damage

Stitching

Visual and Touch Inspection

- ✗ Pulled stitches
- ✗ Stitching that is missing
- ✗ Hard or shiny spots Indicates heat damage
- ✗ Cut stitches
- ✗ ✓ Discoloration of stitching Dependant on cause of discoloration

Hardware

Visual and Touch Inspection

- ✗ Distortion (twists, bends) ✗ Rough or sharp edges
- ✗ Rust or corrosion ✗ Cracks or breaks
- ✗ Broken/distorted grommets
- ✗ Modification by users (ie additional holes)
- ✗ Tongue buckle should overlap the buckle frame and move freely back and forth in their socket
- ✗ Roller of tongue buckle should turn freely on frame
- ✗ Bars must be straight
- ✗ All springs must be in working condition

Harness Inspection – Guidelines

Tagging System

Every harness must have a legible tag identifying the harness, model, date of manufacture, name of manufacturer, limitations and warnings.

- ✘ Check tag for date of manufacture and remove from service if past adopted service life policy
- ✘ If tagging system is missing or not legible remove harness from service.

Cleaning and Storage

Wipe off all surface dirt with a sponge dampened in plain water. Squeeze the sponge dry. Dip the sponge in a mild solution of water and mild detergent. Work up a thick lather, with a vigorous back and forth motion. Then wipe dry with a clean cloth.

Hang freely to dry, but away from excessive heat, steam or long periods of sunlight.

Storage areas should be clean, dry and free of exposure to fumes, heat, direct ultra violet light, sunlight and corrosive elements.

Note: Do not store harnesses next to batteries, chemical attack can occur if battery leaks.

INSPECTION CHECKLIST - HARNESS

ITEM DESCRIPTION

- 1. X ✓ Dee Ring
- 2. X ✓ Dee Pad
- 3. X ✓ Nylon Webbing
- 4. X ✓ Spring Loaded Friction Buckles
- 5. X ✓ Elastic Keepers (2)
- 6. X ✓ Nylon Webbing
- 7. X ✓ Spring Loaded Friction Buckles
- 8. X ✓ Elastic Keepers (2)
- 9. X ✓ Nylon Webbing
- 10. X ✓ Stitching
- 11. X ✓ Stitching
- 12. X ✓ Tongue Buckle
- 13. X ✓ Elastic Keeper (1)
- 14. X ✓ Nylon Webbing
- 15. X ✓ Stitching
- 16. X ✓ Stitching
- 17. X ✓ Tongue Buckle
- 18. X ✓ Elastic Keeper (1)
- 19. X ✓ Stitching
- 20. X ✓ Nylon Webbing
- 21. X ✓ Stitching
- 22. X ✓ Stitching
- 23. X ✓ Nylon Webbing
- 24. X ✓ Grommets
- 25. X ✓ Stitching
- 26. X ✓ Nylon Webbing
- 27. X ✓ Stitching
- 28. X ✓ Stitching
- 29. X ✓ Nylon Webbing
- 30. X ✓ Grommets
- 31. X ✓ Sub-Pelvic Strap
- 32. X ✓ Back Strap
- 33. X ✓ Stitching - Back Strap
- 34. X ✓ Stitching - Back Strap
- 35. X ✓ Chest Strap Pad
- 36. X ✓ Nylon Webbing
- 37. X ✓ Stitching
- 38. X ✓ Mating Link
- 39. X ✓ Chest Strap Pad
- 40. X ✓ Nylon Webbing
- 41. X ✓ Stitching
- 42. X ✓ 3 Bar Mating Buckle
- 43. X ✓ Elastic Keeper (1)
- 44. X ✓ Tagging/Label System

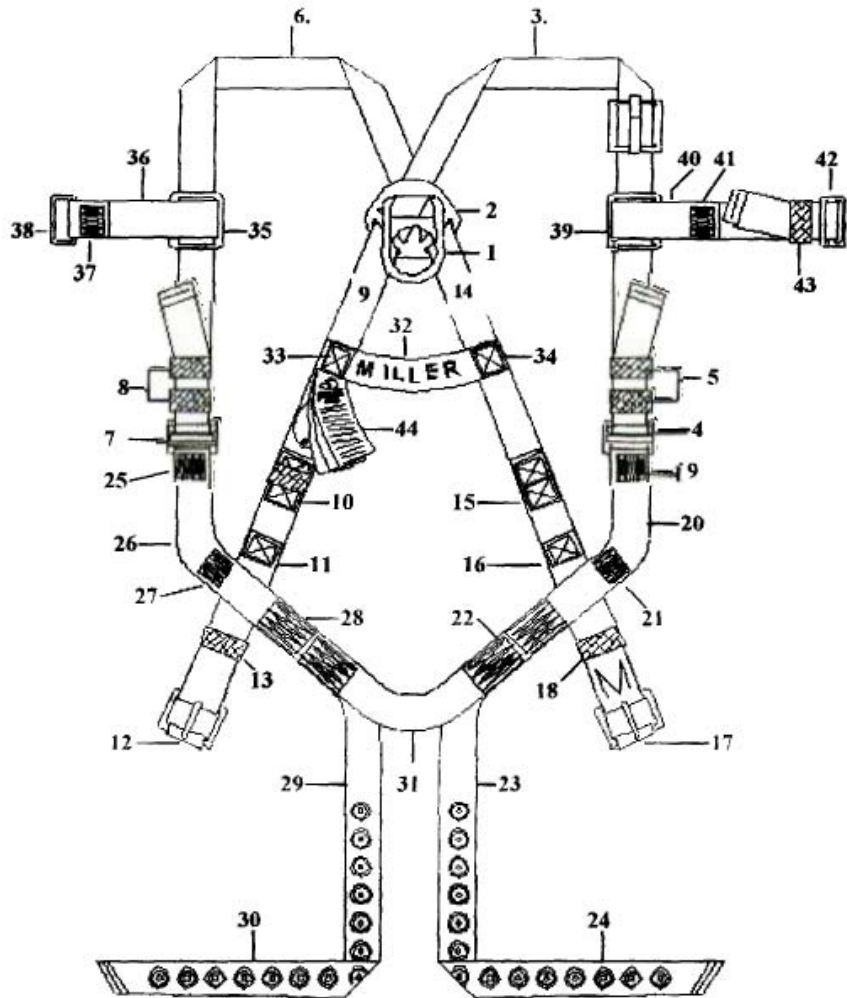

CRITERIA X = FAIL
 ✓ = PASS

SERIAL # _____	DATE OF MANUF _____
INSPECTOR _____	DATE OF INSPECTION _____
INSPECTOR SIGNATURE _____	
X FAIL: <input type="checkbox"/> Initial _____	✓ PASS: <input type="checkbox"/> Initial _____
REMOVE FROM SERVICE	RETURN TO SERVICE

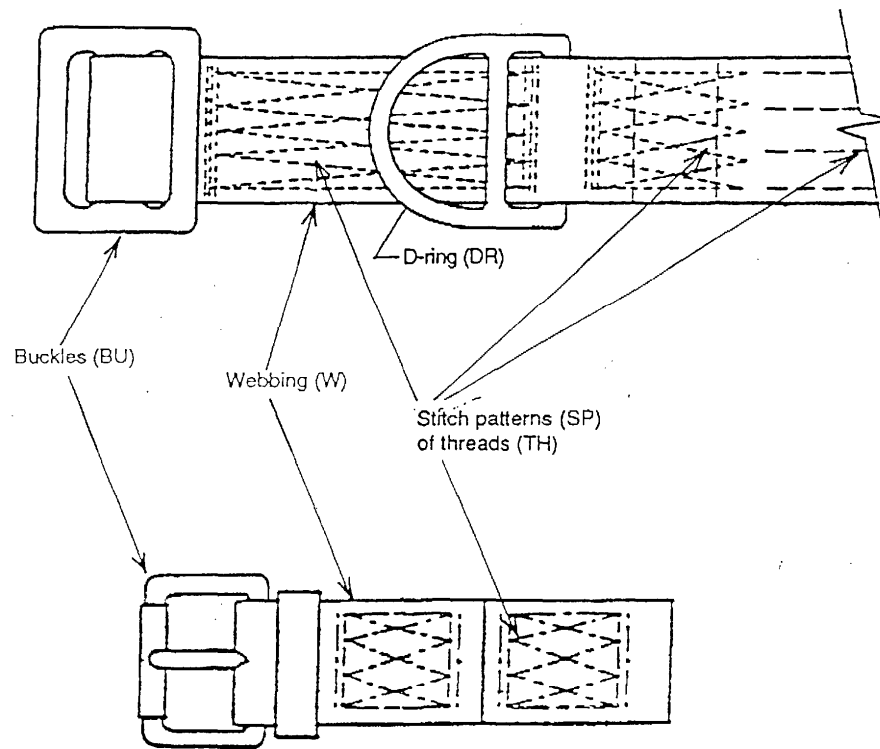

Examples of Some Typical
Thread (TH) and Stitch Patterns (SP) in Webbing (W)

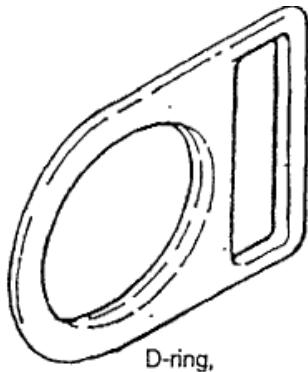

D-ring,

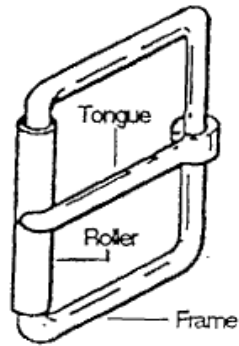

Buckle, tongue

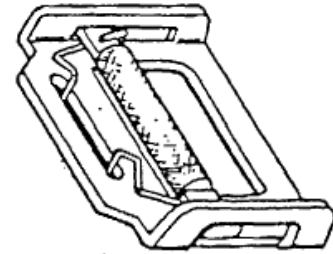

Adjuster, webbing
(Also a buckle)

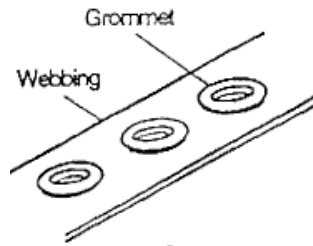

Grommets in webbing

Example of Some Typical
Connector (Hardware) Components and Elements

Lanyard Inspection

Shock Absorbing Lanyard (Manyard Style) Inspection – Guidelines

Webbing

Grasp the webbing with your hands and bend the webbing, checking both sides. This creates surface tension making damaged fibers or cuts easier to see. Webbing damage may not show up through a sight (visual) inspection only – manual (touch) the lanyard is equally important. **Pay attention to the wrinkled portion of the lanyard.**

Visual and Touch Inspection

✓ Pass

✗ Fail Criteria

✗ Cuts, nicks or tears

✗ Broken fibers/cracks

✗ Overall deterioration

✗ Modifications by user

✗ Fraying/Abrasions

✗ ✓ Discoloration of material

Dependant on cause of discoloration

✗ Hard or shiny spots

Indicates heat damage

✗ Change in core size

Indicates possible fall

✓ Mildew

Clean lanyard

✗ Missing or popped flag

Indicates possible fall

✗ Undue Stretching

Indicates possible fall

✗ Burnt, charred or melted fibers

Indicates heat damage

✗ ✓ Material marked w/permanent marker

Check w/manufacturer

✗ Excessive hardness or brittleness

Indicates heat or uv damage

✗ Knots in lanyard

Stitching

Visual and Touch Inspection

✗ Pulled stitches

✗ Stitching that is missing

✗ Hard or shiny spots

Indicates heat damage

✗ Cut stitches

✗ ✓ Discoloration of stitching

Dependant on cause of discoloration

Shock Absorbing Lanyard (Manyard Style) Inspection – Guidelines

Snap Hooks

Snap hooks should be of the self-locking type. Snap hooks are generally proof tested to 3,600 lbs. and have minimum tensile strength of 5,000lbs.

Visual and Manual Inspection

✓ Pass

✗ Fail Criteria

Snap Hook

- ✗ Snap hooks should be of the self-locking type
- ✗ No hook or eye distortion (twists, bends or elongation)
- ✗ Latch/keeper should seat into the nose w/o binding
- ✗ Latch/keeper should not be distorted or obstructed
- ✗ Overall deterioration/Excessive wear
- ✗ Modifications by the user
- ✗ Rust/pitting/corrosion
- ✗ No cracks
- ✗ No excessive wear
- ✗ No missing parts
- ✗ No rough or sharp edges

Snap Hook Locking Mechanism

- ✗ Disengage locking mechanism and open keeper (keeper should open freely)
- ✗ Disengage locking mechanism and release (locking mechanism should return to engaged position).

Snap Hook Keeper

- ✗ Check keeper spring action by opening the keeper and releasing. (Keeper should return to closed position without hanging up it should not close slowly.)
- ✗ Push on keeper without engaging locking mechanism (keeper should not open)
- ✗ Check to see the keeper is seated firmly on the snap hook nose – there should be no side play. (lateral movement)

Tagging System

Every lanyard must have a legible tag identifying the lanyard, model, date of manufacture, name of manufacturer, limitations and warnings.

- ✗ Check tag for date of manufacture and remove from service if past adopted service life policy
- ✗ If tagging system is missing remove lanyard from service.

Shock Absorbing Lanyard (Manyard) Inspection – Guidelines

Cleaning and Storage

Wipe off all surface dirt with a sponge dampened in plain water. Squeeze the sponge dry. Dip the sponge in a mild solution of water and mild detergent. Work up a thick lather, with a vigorous back and forth motion. Then wipe dry with a clean cloth.

Hang freely to dry, but away from excessive heat, steam or long periods of sunlight.

Storage areas should be clean, dry and free of exposure to fumes, heat, direct ultra violet light, sunlight and corrosive elements.

Note: Do not store lanyards next to batteries, chemical attack on the lanyard can occur if battery leaks.

NOTES

Inspection Checklist – Fall Protection Equipment

Shock Absorbing Lanyard (Manyard)

Description:	Model #:
Serial #:	Date of Manufacture:
Inspector:	Date Inspected:
Inspector Signature:	

✘ **FAIL:** Initial _____
REMOVE FROM SERVICE

✔ **PASS:** Initial _____
RETURN TO SERVICE

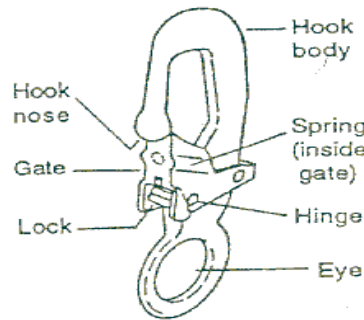
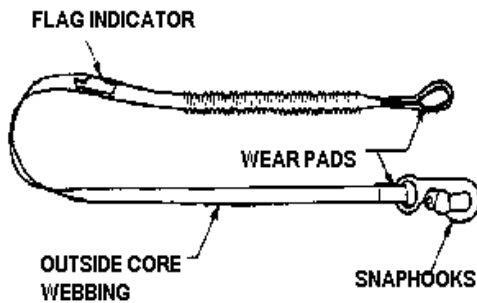

Figure 1n
 Snaphook, Self-locking

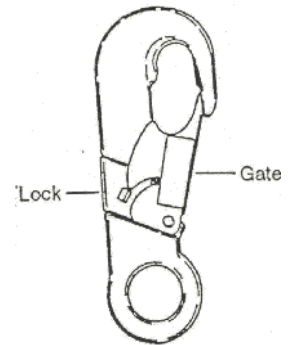

Figure 1k
 Snaphook, Self-locking
 Style B

Style A

ITEM #	DESCRIPTION – LANYARD	FAIL ✘	PASS ✔	COMMENTS
	Flag Indicator			
	Outside Core Webbing			
	Core			
	Stitching			
	Labeling (tags)			
	Wear Pads			
	SNAPHOOK			
	Hook Body			
	Hook Nose			
	Gate (keeper)			
	Lock			
	Eye			
	Hinge			
	Spring (inside gate)			

Rope Lanyards (Synthetic) Inspection – Guidelines

Thimbles and Eyes

Visual and Touch Inspection

✓ Pass

✗ Fail Criteria

Thimbles (steel or plastic) must be seated firmly in the eye. Thimbles must not show any sign of damage. Check around the eye itself for damage, wear or deterioration.

- ✗ Missing thimble(s)
- ✗ Loose thimble(s)
- ✗ Damaged thimbles - white stress marks, thimble collapsing over itself
- ✗ Eye damage due to cuts, nicks, abrasions, fraying, fused areas (look for same indicators as you would for the rope body itself.)
- ✗ Eyes with metal thimbles – look for rust in or around the eye.

Rope Splices

In the construction of the lanyard the rope is spliced around a plastic or metal thimble. Eye splices in twisted rope having three or more strands shall have a minimum of four tucks (ANSI Z359.1-1992). (CSA-Z259.1-95 requires a minimum of five full tucks.) Both standards require the ends secured to prevent unraveling.

Visual and Touch Inspection

✓ Pass

✗ Fail Criteria

- ✗ Splices not secured properly from unraveling – look for tape, shrink wrap tube, stiffening agent. (most common methods used by manufacturers.)
- ✗ Splices starting to unravel
- ✗ Splices showing damage or deterioration (look for same indicators as you would for the rope itself.)

Rope Lanyards (Synthetic) Inspection – Guidelines

Snap Hooks

Snap hooks should be of the self-locking type. Snap hooks are generally proof tested to 3,600 lbs. and have minimum tensile strength of 5,000lbs.

Visual and Manual Inspection

✓ Pass

✗ Fail Criteria

Snap Hook

- ✗ Snap hooks should be of the self-locking type
- ✗ No hook or eye distortion (twists, bends or elongation)
- ✗ Latch/keeper should seat into the nose w/o binding
- ✗ Latch/keeper should not be distorted or obstructed
- ✗ Overall deterioration/Excessive wear
- ✗ Modifications by the user
- ✗ Rust/pitting/corrosion
- ✗ No cracks
- ✗ No excessive wear
- ✗ No missing parts
- ✗ No rough or sharp edges

Snap Hook Locking Mechanism

- ✗ Disengage locking mechanism and open keeper (keeper should open freely)
- ✗ Disengage locking mechanism and release (locking mechanism should return to engaged position).

Snap Hook Keeper

- ✗ Check keeper spring action by opening the keeper and releasing. (Keeper should return to closed position without hanging up it should not close slowly.)
- ✗ Push on keeper without engaging locking mechanism (keeper should not open)
- ✗ Check to see the keeper is seated firmly on the snap hook nose – there should be no side play. (lateral movement)

Tagging System

Every lanyard must have a legible tag identifying the lanyard, model, date of manufacture, name of manufacturer, limitations and warnings.

- ✗ Check tag for date of manufacture and remove from service if past adopted service life policy
- ✗ If tagging system is missing or not legible remove lanyard from service.

Rope Lanyards (Synthetic) Inspection – Guidelines

Cleaning and Storage

Wipe off all surface dirt with a sponge dampened in plain water. Squeeze the sponge dry. Dip the sponge in a mild solution of water and mild detergent. Work up a thick lather, with a vigorous back and forth motion. Then wipe dry with a clean cloth.

Hang freely to dry, but away from excessive heat, steam or long periods of sunlight. Lanyards must be dry before storage.

Storage areas should be clean, dry and free of exposure to fumes, heat, direct ultra violet light, sunlight and corrosive elements. Lanyards should be kept off the floor to provide ventilation underneath. Never store directly on a concrete or dirt floor.

Note: Do not store lanyards next to batteries, chemical attack on the lanyard can occur if battery leaks.

Inspection Checklist – Fall Protection Equipment

Rope Lanyards - Synthetic

Description:	Model #:
Serial #:	Date of Manufacture:
Inspector:	Date Inspected:
Inspector Signature:	

✘ **FAIL:** Initial _____
REMOVE FROM SERVICE

✔ **PASS:** Initial _____
RETURN TO SERVICE

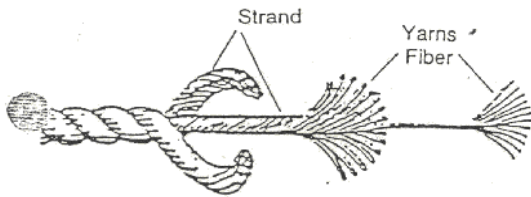

Figure 14a
Synthetic Rope Composition
(Three-Strand Laid Rope)

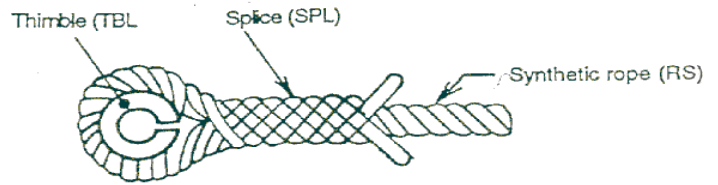

Figure 6b
Spliced Eye

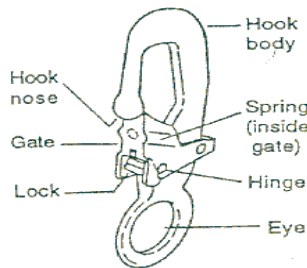

Figure 1n
Snaphook, Self-locking

ITEM #	DESCRIPTION – LANYARD	FAIL ✘	PASS ✔	COMMENTS
	Rope Fibers			
	Rope Splices			
	Thimbles & Eyes			
	Rope Diameter			
	Labeling (tags)			
	Rope Hockling			
	SNAPHOOK			
	Hook Body			
	Hook Nose			
	Gate (keeper)			
	Lock			
	Eye			
	Hinge			
	Spring (inside gate)			

Web Lanyards

Inspection – Guidelines

Webbing

Grasp the webbing with your hands and bend the webbing, checking both sides. This creates surface tension making damaged fibers or cuts easier to see. Webbing damage may not show up through a sight (visual) inspection only – manual (touch) inspection of the lanyard is equally important.

Visual and Touch Inspection

✓ Pass

✗ Fail Criteria

- ✗ Cuts, nicks or tears
- ✗ Broken fibers/cracks
- ✗ Overall deterioration
- ✗ Modifications by user
- ✗ Fraying/Abrasions

✗✓ Discoloration of material

Dependant on cause of discoloration

✗ Hard or shiny spots

Indicates heat damage

✗ Change in core size

Indicates possible fall

✓ Mildew

Clean lanyard

✗ Undue Stretching

Indicates possible fall

✗ Burnt, charred or melted fibers

Indicates heat damage

✗✓ Material marked w/permanent marker

Check w/manufacturer

✗ Excessive hardness or brittleness

Indicates heat or uv damage

✗ Knots in lanyard

Stitching

Visual and Touch Inspection

✗ Pulled stitches

✗ Stitching that is missing

✗ Hard or shiny spots

Indicates heat damage

✗ Cut stitches

✗✓ Discoloration of stitching

Dependant on cause of discoloration

Web Lanyards Inspection – Guidelines

Snap Hooks

Snap hooks should be of the self-locking type. Snap hooks are generally proof tested to 3,600 lbs. and have minimum tensile strength of 5,000lbs.

Visual and Manual Inspection

✓ Pass

✗ Fail Criteria

Snap Hook

- ✗ Snap hooks should be of the self-locking type
- ✗ No hook or eye distortion (twists, bends or elongation)
- ✗ Latch/keeper should seat into the nose w/o binding
- ✗ Latch/keeper should not be distorted or obstructed
- ✗ Overall deterioration/Excessive wear
- ✗ Modifications by the user
- ✗ Rust/pitting/corrosion
- ✗ No cracks
- ✗ No excessive wear
- 6No missing parts
- 6No rough or sharp edges

Snap Hook Locking Mechanism

- ✗ Disengage locking mechanism and open keeper (keeper should open freely)
- ✗ Disengage locking mechanism and release (locking mechanism should return to engaged position.)

Snap Hook Keeper

- ✗ Check keeper spring action by opening the keeper and releasing. (Keeper should return to closed position without hanging up it should not close slowly.)
- ✗ Push on keeper without engaging locking mechanism (keeper should not open)
- ✗ Check to see the keeper is seated firmly on the snap hook nose – there should be no side play. (lateral movement)

Tagging System

Every lanyard must have a legible tag identifying the lanyard, model, date of manufacture, name of manufacturer, limitations and warnings.

- ✗ Check tag for date of manufacture and remove from service if past adopted service life policy
- ✗ If tagging system is missing or not legible remove lanyard from service.

Web Lanyards Inspection – Guidelines

Cleaning and Storage

Wipe off all surface dirt with a sponge dampened in plain water. Squeeze the sponge dry. Dip the sponge in a mild solution of water and mild detergent. Work up a thick lather, with a vigorous back and forth motion. Then wipe dry with a clean cloth.

Hang freely to dry, but away from excessive heat, steam or long periods of sunlight. Lanyards must be dry before storage.

Storage areas should be clean, dry and free of exposure to fumes, heat, direct ultra violet light, sunlight and corrosive elements.

Note: Do not store lanyards next to batteries, chemical attack on the lanyard can occur if battery leaks.

Inspection Checklist – Fall Protection Equipment

Web Lanyards

Description:	Model #:
Serial #:	Date of Manufacture:
Inspector:	Date Inspected:
Inspector Signature:	

✘ **FAIL:** Initial _____
REMOVE FROM SERVICE

✔ **PASS:** Initial _____
RETURN TO SERVICE

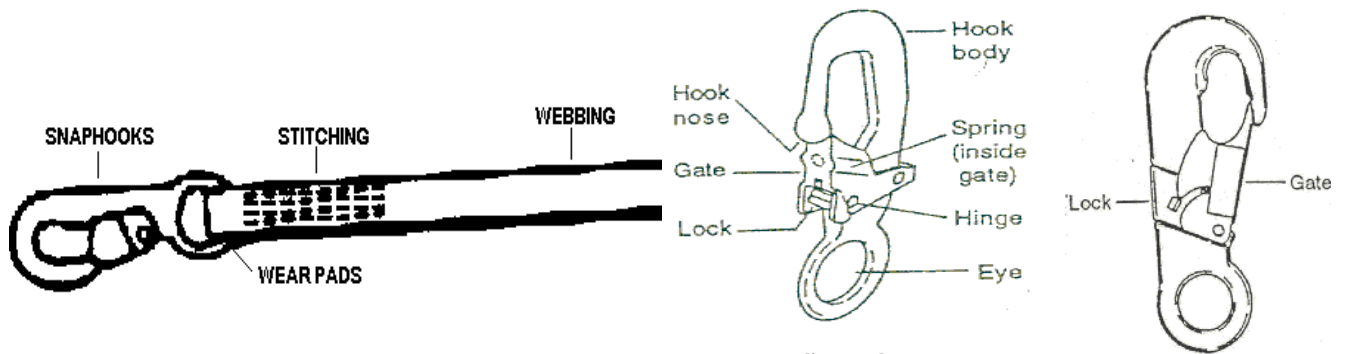

Figure 1n
Snaphook, Self-locking

Figure 1k
Snaphook, Self-locking
Style B

Style A

ITEM #	DESCRIPTION – LANYARD	FAIL	PASS	COMMENTS
		✘	✔	
	Webbing			
	Stitching			
	Wear Pads			
	Labeling (tags)			
	SNAPHOOK			
	Hook Body			
	Hook Nose			
	Gate (keeper)			
	Lock			
	Eye			
	Hinge			
	Spring (inside gate)			

Wire Rope Lanyards Inspection – Guidelines

Wire Rope

Grasp the steel lanyard with your hands and rotate the lanyard, checking both sides. Watch for unusual wearing patterns on the wire. Broken strands or wires will separate from the body of the lanyard. **To avoid hand injury always wear protective gloves when inspecting a wire rope lanyard.**

Note: Unlike rigging inspection standards, wire rope used for the purpose of fall protection does not allow any broken wires or strands.

Visual and Touch Inspection

✓ Pass

✗ Fail Criteria

- ✗ Cuts, frayed areas
- ✗ Worn or broken strands/wires
- ✗ Overall deterioration/Excessive outside wear
- ✗ Modifications by the user
- ✗ Rust/pitting/corrosion
- ✗ Crushed/jammed or flattened strands
- ✗ Bulges in rope
- ✗ Gaps between strands
- ✗ Heat damage, torch burns or electric arc strikes
- ✗ Kinks, bird-caging
- ✗ Core protrusion
- ✗ Do not use frozen rope

Fittings

- ✗ Wear or Cracks
- ✗ Corrosion or Pitting
- ✗ Deformation/Bends
- ✗ Mismatched Parts or Modifications
- ✗ Obvious Damage

Splices

- ✗ Worn or broken wires
- ✗ Crushed/jammed or flattened strands
- ✗ Corrosion

Inspection – Guidelines

Wire Rope Lanyards

Snap Hooks

Snap hooks should be of the self-locking type. Snap hooks are generally proof tested to 3,600 lbs. and have minimum tensile strength of 5,000lbs.

Visual and Manual Inspection

✓ Pass

✗ Fail Criteria

Snap Hook

- ✗ Snap hooks should be of the self-locking type
- ✗ No hook or eye distortion (twists, bends or elongation)
- ✗ Latch/keeper should seat into the nose w/o binding
- ✗ Latch/keeper should not be distorted or obstructed
- ✗ Overall deterioration/Excessive wear
- ✗ Modifications by the user
- ✗ Rust/pitting/corrosion
- ✗ No cracks
- ✗ No excessive wear
- ✗ No missing parts
- ✗ No rough or sharp edges

Snap Hook Locking Mechanism

- ✗ Disengage locking mechanism and open keeper (keeper should open freely)
- ✗ Disengage locking mechanism and release (locking mechanism should return to engaged position.)

Snap Hook Keeper

- ✗ Check keeper spring action by opening the keeper and releasing. (Keeper should return to closed position without hanging up it should not close slowly.)
- ✗ Push on keeper without engaging locking mechanism (keeper should not open)
- ✗ Check to see the keeper is seated firmly on the snap hook nose – there should be no side play. (lateral movement)

Tagging System

Every lanyard must have a legible tag identifying the lanyard, model, date of manufacture, name of manufacturer, limitations and warnings.

- ✗ Check tag for date of manufacture and remove from service if past adopted service life policy
- ✗ If tagging system is missing or not legible remove lanyard from service.

Cleaning and Storage

Wipe off all surface dirt , dust and extra oils with a dry cloth.

Storage areas should be clean, dry and free of exposure to contaminants or corrosive elements.

Inspection Checklist – Fall Protection Equipment

Wire Rope Lanyards

Description:	Model #:
Serial #:	Date of Manufacture:
Inspector:	Date Inspected:
Inspector Signature:	

✘ **FAIL:** ✓ Initial _____
REMOVE FROM SERVICE

✓ **PASS:** ☐ Initial _____
RETURN TO SERVICE

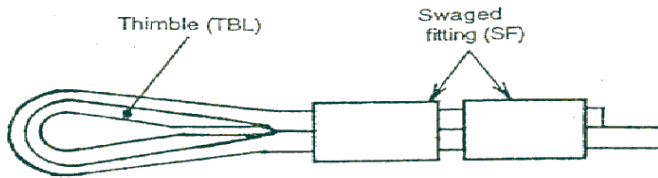

Figure 6a
Return Eye

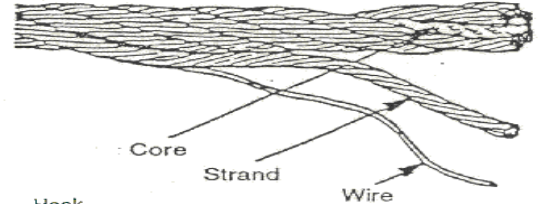

Figure 14e
Wire Rope Composition

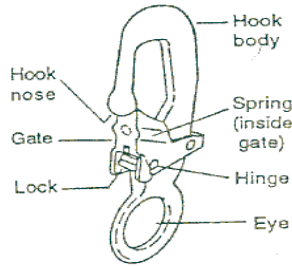

Figure 1n
Snaphook, Self-locking

ITEM #	DESCRIPTION – LANYARD	FAIL ✘	PASS ✓	COMMENTS
	Broken Wires			
	Rust/Corrosion/Pitting			
	Deformations			
	Heat Damage			
	Fittings/Thimbles			
	Splices			
	Labeling (tags)			
	SNAPHOOK			
	Hook Body			
	Hook Nose			
	Gate (keeper)			
	Lock			
	Eye			
	Hinge			
	Spring (inside gate)			

Shock Absorbers – Pouch Style Inspection – Guidelines

Shock Absorbers – Pouch Style

Examine the outer portion of the pack.

Visual and Touch Inspection

✓ Pass

✗ Fail Criteria

- ✗ Burn holes
- ✗ Tears/cuts
- ✗ Modifications by user
- ✗ Chemical attack
- ✗ Obvious signs of deterioration

Stitching

Visual and Touch Inspection

- ✗ Pulled stitches
- ✗ Stitching that is missing
- ✗ Hard or shiny spots
- ✗ Cut stitches
- ✗ ✓ Discoloration of stitching
- ✗ Obvious signs of deterioration

Indicates heat damage

Dependant on cause of discoloration

End Loops

- ✗ Cuts or frays
 - ✗ Obvious signs of deterioration
- (There should be no damage to the end loops)

Shock Absorbers – Pouch Style Inspection – Guidelines

Snap Hooks

Snap hooks should be of the self-locking type. Snap hooks are generally proof tested to 3,600 lbs. and have minimum tensile strength of 5,000lbs.

Visual and Manual Inspection

✓ Pass

✗ Fail Criteria

Snap Hook

- ✗ Snap hooks should be of the self-locking type
- ✗ No hook or eye distortion (twists, bends or elongation)
- ✗ Latch/keeper should seat into the nose w/o binding
- ✗ Latch/keeper should not be distorted or obstructed

- ✘ Overall deterioration/Excessive wear
- ✘ Modifications by the user
- ✘ Rust/pitting/corrosion
- ✘ No cracks
- ✘ No excessive wear
- ✘ No missing parts
- ✘ No rough or sharp edges

Snap Hook Locking Mechanism

- ✘ Disengage locking mechanism and open keeper (keeper should open freely)
- ✘ Disengage locking mechanism and release (locking mechanism should return to engaged position).

Snap Hook Keeper

- ✘ Check keeper spring action by opening the keeper and releasing. (Keeper should return to closed position without hanging up it should not close slowly.)
- ✘ Push on keeper without engaging locking mechanism (keeper should not open)
- ✘ Check to see the keeper is seated firmly on the snap hook nose – there should be no side play. (lateral movement)

Tagging System

Every pouch must have a legible tag identifying the pouch, model, date of manufacture, name of manufacturer, limitations and warnings.

- ✘ Check tag for date of manufacture and remove from service if past adopted service life policy
- ✘ If tagging system is missing or not legible remove lanyard from service.

Shock Absorbers – Pouch Style Inspection – Guidelines

Cleaning and Storage

Wipe off all surface dirt with a sponge dampened in plain water. Squeeze the sponge dry. Then wipe away any excess moisture with a dry clean cloth.

Dry away from excessive heat, steam or long periods of sunlight. Pouch must be dry before storage.

Storage areas should be clean, dry and free of exposure to fumes, heat, direct ultra violet light, sunlight and corrosive elements.

Note: Do not store pouch next to batteries, chemical attack on the lanyard can occur if battery leaks.

Inspection Checklist – Fall Protection Equipment

Shock Absorbers Pouch Style

Description:	Model #:
Serial #:	Date of Manufacture:
Inspector:	Date Inspected:
Inspector Signature:	

✘ **FAIL:** Initial _____
REMOVE FROM SERVICE

✔ **PASS:** Initial _____
RETURN TO SERVICE

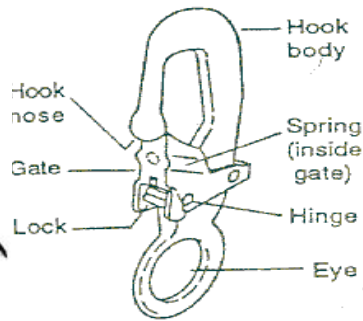
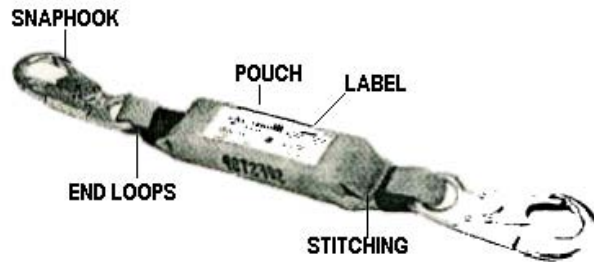

Figure 1n
Snaphook, Self-locking

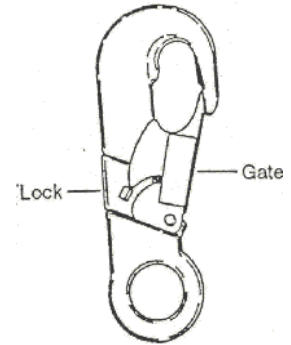

Figure 1k
Snaphook, Self-locking

Style A

Style B

ITEM #	DESCRIPTION – LANYARD	FAIL ✘	PASS ✔	COMMENTS
	Pouch Damage			
	Stitching			
	End Loops			
	Labeling (tags)			
	SNAPHOOK			
	Hook Body			
	Hook Nose			
	Gate (keeper)			
	Lock			
	Eye			
	Hinge			
	Spring (inside gate)			

Synthetic Rope – Lifelines (Twisted Ropes) Inspection – Guidelines

Thimbles and Eyes

Visual and Touch Inspection

✓ Pass

✘ Fail Criteria

Thimbles (steel or plastic) must be seated firmly in the eye. Thimbles must not show any sign of damage. Check around the eye itself for damage, wear or deterioration.

- ✘ Missing thimble(s)
- ✘ Loose thimble(s)
- ✘ Damaged thimble - white stress marks, thimble collapsing over itself
- ✘ Eye damage due to cuts, nicks, abrasions, fraying, fused areas (look for same indicators as you would for the rope body itself.
- ✘ Eyes with metal thimbles – look for rust in or around the eye.

Rope Splices

In the construction of the lifeline the rope is spliced around a plastic or metal thimble. Eye splices in twisted rope having three or more strands shall have a minimum of four tucks (ANSI Z359.1-1992). (CSA-Z259.1-95 requires a minimum of five full tucks.) Both standards require the ends secured to prevent unraveling.

Visual and Touch Inspection

✓ Pass

✘ Fail Criteria

- ✘ Splices not secured properly from unraveling – look for tape, shrink wrap tube, stiffening agent. (most common methods used by manufacturers.)
- ✘ Splices starting to unravel
- ✘ Splices showing damage or deterioration (look for same indicators as you would for the rope itself.

Synthetic Rope – Lifelines (Twisted Ropes) Inspection – Guidelines

Snap Hooks

Snap hooks should be of the self-locking type. Snap hooks are generally proof tested to 3,600 lbs. and have minimum tensile strength of 5,000lbs.

Visual and Manual Inspection

✓ Pass

✗ Fail Criteria

Snap Hook

- ✗ Snap hooks should be of the self-locking type
- ✗ No hook or eye distortion (twists, bends or elongation)
- ✗ Latch/keeper should seat into the nose w/o binding
- ✗ Latch/keeper should not be distorted or obstructed
- ✗ Overall deterioration/Excessive wear
- ✗ Modifications by the user
- ✗ Rust/pitting/corrosion
- ✗ No cracks
- ✗ No excessive wear
- ✗ No missing parts
- ✗ No rough or sharp edges

Snap Hook Locking Mechanism

- ✗ Disengage locking mechanism and open keeper (keeper should open freely)
- ✗ Disengage locking mechanism and release (locking mechanism should return to engaged position.)

Snap Hook Keeper

- ✗ Check keeper spring action by opening the keeper and releasing. (Keeper should return to closed position without hanging up it should not close slowly.)
- ✗ Push on keeper without engaging locking mechanism (keeper should not open)
- ✗ Check to see the keeper is seated firmly on the snap hook nose – there should be no side play. (lateral movement)

Tagging System

Lifelines must have a legible tag identifying the, model, date of manufacture, name of manufacturer, limitations and warnings.

- ✗ Check tag for date of manufacture and remove from service if past adopted service life policy
- ✗ If tagging system is missing or not legible remove lifeline from service.

Synthetic Rope – Lifelines (Twisted Ropes) Inspection – Guidelines

Cleaning and Storage

Rope can be washed, to remove dirt or abrasive particles. Use a solution of mild detergent and cold water. (Note that washing can remove any coatings that may have been added to enhance the performance of the product)

Hang freely to dry, but away from excessive heat, steam or long periods of sunlight. Lifelines must be dry before storage.

Storage areas should be clean, dry and free of exposure to fumes, heat, direct ultra violet light, sunlight and corrosive elements. Lifelines should be kept off the floor to provide ventilation underneath. Never store directly on a concrete or dirt floor.

Note: Do not store lifelines next to batteries, chemical attack on the lifeline can occur if battery leaks.

Inspection Checklist – Fall Protection Equipment Rope Lifelines - Synthetic

Description:	Model #:
Serial #:	Date of Manufacture:
Inspector:	Date Inspected:
Inspector Signature:	

✘ **FAIL:** Initial _____
REMOVE FROM SERVICE

✔ **PASS:** Initial _____
RETURN TO SERVICE

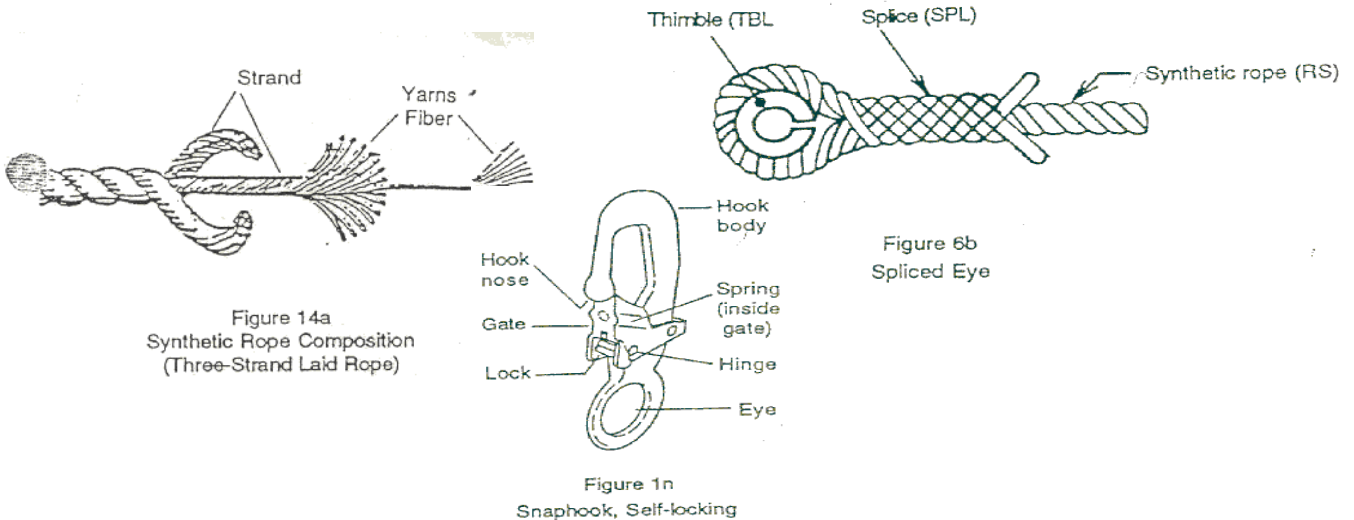

ITEM #	DESCRIPTION – LANYARD	FAIL ✘	PASS ✔	COMMENTS
	Rope Fibers			
	Rope Splices			
	Thimbles & Eyes			
	Rope Diameter			
	Labeling (tags)			
	Rope Hockling			
	SNAPHOOK			
	Hook Body			
	Hook Nose			
	Gate (keeper)			
	Lock			
	Eye			
	Hinge			
	Spring (inside gate)			

Synthetic Rope – Lifelines - Braided Ropes Inspection – Guidelines

Braided Ropes

Grasp the rope with both hands and rotate the lifeline. Run your hands along the entire length of lifeline. Inspect strands from end to end.

Synthetic fiber ropes will show a reduction in strength when used at elevated temperatures. For exposure to excessive temperatures specific for the rope fiber refer to the rope manufacturers specifications and instructions.

Damage and deterioration may not show up through a sight (visual) inspection only – manual (touch) the lanyard is equally important.

Rope Diameter

Weakened areas from extreme loads will appear as a noticeable change in original diameter. The rope diameter should be uniform throughout. If areas appear to be reduced more than *5% from original rope diameter **remove from service** – (ie: 5/8" rope, 5% reduction would be approx. 1/32" – calipers can be used to measure.)

Visual and Touch Inspection

✔ Pass

✘ Fail Criteria

✘ Check for pulled cover strands	More than 4 consecutive pulled cover strands (which cannot be reincorporated into cover braid) Remove from service
✘ Cover damage-core visible	
✘ Core damage-pulled, cut, abraded, powdered or melted strands	
✘ Cover-cuts or nicks	
✘ Cover-broken fibers	
✘ Overall deterioration	
✘ Modifications by user	
✘ Fraying/Abrasions	
✘ Hard or shiny spots	Indicates heat damage
✘ Fused fibers or strands	Indicates heat damage
✘ Change in original diameter	Indicates possible fall
✘ Burnt, charred or melted fibers	Indicates heat damage
✘ ✓ Material marked w/permanent marker	Check w/manufacturer
✘ Knots or kinks	
✘ ✓ Discoloration of rope & brittle fibers (such as splinters/slivers)	Dependant on cause of discoloration but may indicate chemical attack or UV degradation

Synthetic Rope – Lifelines (Braided Ropes) Inspection – Guidelines

Thimbles and Eyes

Visual and Touch Inspection

✓ Pass

✘ Fail Criteria

Thimbles (steel or plastic) must be seated firmly in the eye. Thimbles must not show any sign of damage. Check around the eye itself for damage, wear or deterioration.

- ✘ Missing thimble(s)
- ✘ Loose thimble(s)
- ✘ Damaged thimbles - white stress marks, thimble collapsing over itself
- ✘ Damage to female side of eye (side in contact with thimble)
- ✘ Eye damage due to cuts, nicks, abrasions, fraying, fused areas (look for same indicators as you would for the rope body itself).
- ✘ Eyes with metal thimbles – look for rust in or around the eye.

Fittings

- ✘ Wear or Cracks
- ✘ Corrosion or Pitting
- ✘ Deformation/Bends
- ✘ Mismatched Parts or Modifications
- ✘ Obvious Damage

Synthetic Rope – Lifelines (Braided Ropes) Inspection – Guidelines

Snap Hooks

Snap hooks should be of the self-locking type. Snap hooks are generally proof tested to 3,600 lbs. and have minimum tensile strength of 5,000lbs.

Visual and Manual Inspection

✓ Pass

✗ Fail Criteria

Snap Hook

- ✗ Snap hooks should be of the self-locking type
- ✗ No hook or eye distortion (twists, bends or elongation)
- ✗ Latch/keeper should seat into the nose w/o binding
- ✗ Latch/keeper should not be distorted or obstructed
- ✗ Overall deterioration/Excessive wear
- ✗ Modifications by the user
- ✗ Rust/pitting/corrosion
- ✗ No cracks
- ✗ No excessive wear
- ✗ No missing parts
- ✗ No rough or sharp edges

Snap Hook Locking Mechanism

- ✗ Disengage locking mechanism and open keeper (keeper should open freely)
- ✗ Disengage locking mechanism and release (locking mechanism should return to engaged position).

Snap Hook Keeper

- ✗ Check keeper spring action by opening the keeper and releasing. (Keeper should return to closed position without hanging up it should not close slowly.)
- ✗ Push on keeper without engaging locking mechanism (keeper should not open)
- ✗ Check to see the keeper is seated firmly on the snap hook nose – there should be no side play. (lateral movement)

Tagging System

Date of manufacture and length of lifeline can be found on one of the metal ferrules.

- ✗ Check tag for date of manufacture and remove from service if past adopted service life policy
- ✗ If tagging system is missing or not legible remove lifeline from service.

Inspection Checklist – Fall Protection Equipment

Braided Rope Lifelines - Synthetic

Description:	Model #:
Serial #:	Date of Manufacture:
Inspector:	Date Inspected:
Inspector Signature:	

✘ **FAIL:** Initial _____
REMOVE FROM SERVICE

✔ **PASS:** Initial _____
RETURN TO SERVICE

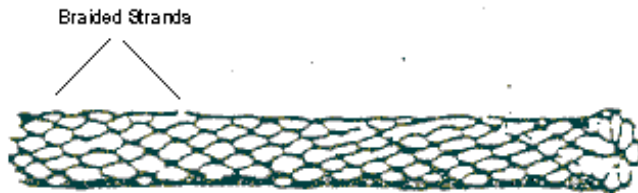

Figure 14b
Solid Braid Rope

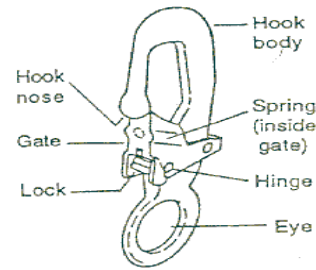

Figure 1n
Snaphook, Self-locking

ITEM #	DESCRIPTION –	FAIL ✘	PASS ✔	COMMENTS
	Rope Diameter			
	Cover Damage			
	Thimbles & Eyes			
	Fittings			
	Labeling (tags)			
	Discoloration			
	SNAPHOOK			
	Hook Body			
	Hook Nose			
	Gate (keeper)			
	Lock			
	Eye			
	Hinge			
	Spring (inside gate)			

Synthetic Rope – Lifelines (Kernmantle Ropes) Inspection – Guidelines

Thimbles And Eyes

Visual and Touch Inspection

✓ Pass

✗ Fail Criteria

Thimbles (steel or plastic) must be seated firmly in the eye. Thimbles must not show any sign of damage. Check around the eye itself for damage, wear or deterioration.

- ✗ Missing thimble(s)
- ✗ Loose thimble(s)
- ✗ Damaged thimbles
- ✗ Damage to female side of eye (side in contact with thimble)
- ✗ Eye damage due to cuts, nicks, abrasions, fraying, fused areas (look for same indicators as you would for the rope body itself).
- ✗ Eyes with metal thimbles – look for rust in or around the eye.

Fittings

- ✗ Wear or Cracks
- ✗ Corrosion or Pitting
- ✗ Deformation/Bends
- ✗ Mismatched Parts or Modifications
- ✗ Obvious Damage

Synthetic Rope – Lifelines (Kernmantle Ropes) Inspection – Guidelines

Snap Hooks

Snap hooks should be of the self-locking type. Snap hooks are generally proof tested to 3,600 lbs. and have minimum tensile strength of 5,000lbs.

Visual and Manual Inspection

✓ Pass

✗ Fail Criteria

Snap Hook

- ✗ Snap hooks should be of the self-locking type
- ✗ No hook or eye distortion (twists, bends or elongation)
- ✗ Latch/keeper should seat into the nose w/o binding
- ✗ Latch/keeper should not be distorted or obstructed
- ✗ Overall deterioration/Excessive wear
- ✗ Modifications by the user
- ✗ Rust/pitting/corrosion
- ✗ No cracks
- ✗ No excessive wear
- ✗ No missing parts
- ✗ No rough or sharp edges

Snap Hook Locking Mechanism

- ✗ Disengage locking mechanism and open keeper (keeper should open freely)
- ✗ Disengage locking mechanism and release (locking mechanism should return to engaged position).

Snap Hook Keeper

- ✗ Check keeper spring action by opening the keeper and releasing. (Keeper should return to closed position without hanging up it should not close slowly.)
- ✗ Push on keeper without engaging locking mechanism (keeper should not open)
- ✗ Check to see the keeper is seated firmly on the snap hook nose – there should be no side play. (lateral movement)

Tagging System

Date of manufacturer can be found on one of the metal ferrules.

- ✗ Check tag for date of manufacture and remove from service if past adopted service life policy
- ✗ If tagging system is missing or not legible remove lifeline from service.

Inspection Checklist – Fall Protection Equipment

Kernmantle Rope Lifelines - Synthetic

Description:	Model #:
Serial #:	Date of Manufacture:
Inspector:	Date Inspected:
Inspector Signature:	

✘ **FAIL:** Initial _____
REMOVE FROM SERVICE

✔ **PASS:** Initial _____
RETURN TO SERVICE

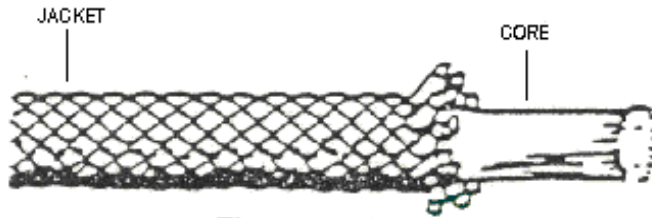

Figure 14d
Static Kernmantle Rope

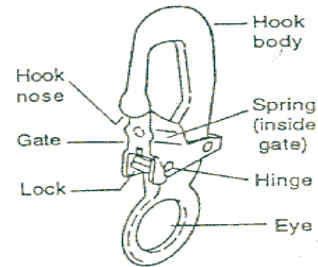

Figure 1n
Snaphook, Self-locking

ITEM #	DESCRIPTION –	FAIL	PASS	COMMENTS
		✘	✔	
	Rope Diameter			
	Cover Damage			
	Thimbles & Eyes			
	Fittings			
	Labeling (tags)			
	Discoloration			
	SNAPHOOK			
	Hook Body			
	Hook Nose			
	Gate (keeper)			
	Lock			
	Eye			
	Hinge			
	Spring (inside gate)			

Synthetic Rope – Lifelines (Polysteel) Inspection – Guidelines

Thimbles and Eyes

Visual and Touch Inspection

✓ Pass

✗ Fail Criteria

Thimbles (steel or plastic) must be seated firmly in the eye. Thimbles must not show any sign of damage. Check around the eye itself for damage, wear or deterioration.

- ✗ Missing thimble(s)
- ✗ Loose thimble(s)
- ✗ Damaged thimbles - white stress marks, thimble collapsing over itself
- ✗ Eye damage due to cuts, nicks, abrasions, fraying, fused areas (look for same indicators as you would for the rope body itself.
- ✗ Eyes with metal thimbles – look for rust in or around the eye.

Rope Splices

In the construction of the lifeline the rope is spliced around a plastic or metal thimble. Eye splices in twisted rope having three or more strands shall have a minimum of four tucks (ANSI Z359.1-1992). (CSA-Z259.1-95 requires a minimum of five full tucks.) Both standards require the ends secured to prevent unraveling.

Visual and Touch Inspection

✓ Pass

✗ Fail Criteria

- ✗ Splices not secured properly from unraveling – look for tape, shrink wrap tube, stiffening agent. (most common methods used by manufacturers.)
- ✗ Splices starting to unravel
- ✗ Splices showing damage or deterioration (look for same indicators as you would for the rope itself.

Synthetic Rope – Lifelines (Polysteel)

Inspection – Guidelines

Snap Hooks

Snap hooks should be of the self-locking type. Snap hooks are generally proof tested to 3,600 lbs. and have minimum tensile strength of 5,000lbs.

Visual and Manual Inspection

✓ Pass

✗ Fail Criteria

Snap Hook

- ✗ Snap hooks should be of the self-locking type
- ✗ No hook or eye distortion (twists, bends or elongation)
- ✗ Latch/keeper should seat into the nose w/o binding
- ✗ Latch/keeper should not be distorted or obstructed
- ✗ Overall deterioration/Excessive wear
- ✗ Modifications by the user
- ✗ Rust/pitting/corrosion
- ✗ No cracks
- ✗ **No excessive wear**
- ✗ No missing parts
- ✗ **No rough or sharp edges**

Snap Hook Locking Mechanism

- ✗ Disengage locking mechanism and open keeper (keeper should open freely)
- ✗ Disengage locking mechanism and release (locking mechanism should return to engaged position).

Snap Hook Keeper

- ✗ Check keeper spring action by opening the keeper and releasing. (Keeper should return to closed position without hanging up it should not close slowly.)
- ✗ Push on keeper without engaging locking mechanism (keeper should not open)
- ✗ Check to see the keeper is seated firmly on the snap hook nose – there should be no side play. (lateral movement)

Tagging System

Lifelines must have a legible tag identifying the, model, date of manufacture, name of manufacturer, limitations and warnings.

- ✗ Check tag for date of manufacture and remove from service if past adopted service life policy
- ✗ If tagging system is missing or not legible remove lifeline from service.

Inspection Checklist – Fall Protection Equipment

Polysteel Rope Lifelines - Synthetic

Description:	Model #:
Serial #:	Date of Manufacture:
Inspector:	Date Inspected:
Inspector Signature:	

✘ **FAIL:** Initial _____
REMOVE FROM SERVICE

✔ **PASS:** Initial _____
RETURN TO SERVICE

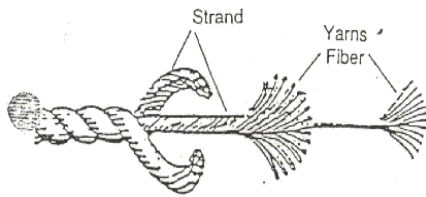

Figure 14a
 Synthetic Rope Composition
 (Three-Strand Laid Rope)

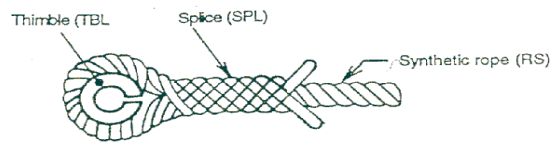

Figure 6b
 Spliced Eye

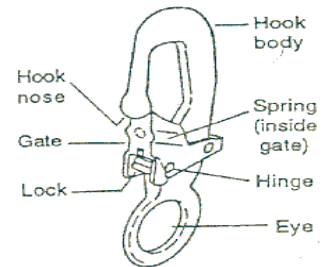

Figure 1n
 Snaphook, Self-locking

ITEM #	DESCRIPTION –	FAIL ✘	PASS ✔	COMMENTS
	Rope Fibers			
	Rope Splices			
	Thimbles & Eyes			
	Rope Diameter			
	Labeling (tags)			
	Rope Hockling			
	SNAPHOOK			
	Hook Body			
	Hook Nose			
	Gate (keeper)			
	Lock			
	Eye			
	Hinge			
	Spring (inside gate)			

Wire Rope Lifelines

Inspection – Guidelines

Wire Rope

Grasp the lifeline with your hands and rotate the lanyard, checking both sides. Watch for unusual wearing patterns on the wire. Broken strands or wires will separate from the body of the lanyard. **To avoid hand injury always wear protective gloves when inspecting a wire rope lanyard.**

Note: Unlike rigging inspection standards, wire rope used for the purpose of fall protection is not allowed any broken wires or strands.

Visual and Touch Inspection

✓ Pass

✗ Fail Criteria

- ✗ Cuts, frayed areas
- ✗ Worn or broken strands/wires
- ✗ Overall deterioration/Excessive outside wear
- ✗ Modifications by the user
- ✗ Rust/pitting/corrosion
- ✗ Crushed/jammed or flattened strands
- ✗ Bulges in rope
- ✗ Gaps between strands
- ✗ Heat damage, torch burns or electric arc strikes
- ✗ Kinks, bird-caging
- ✗ Core protrusion
- ✗ Do not use frozen rope

Fittings

- ✗ Wear or Cracks
- ✗ Corrosion or Pitting
- ✗ Deformation/Bends
- ✗ Mismatched Parts or Modifications
- ✗ Obvious Damage

Splices

- ✗ Worn or broken wires
- ✗ Crushed/jammed or flattened strands
- ✗ Corrosion

Wire Rope Lifelines Inspection – Guidelines

Snap Hooks

Snap hooks should be of the self-locking type. Snap hooks are generally proof tested to 3,600 lbs. and have minimum tensile strength of 5,000lbs.

Visual and Manual Inspection

✓ Pass

✗ Fail Criteria

Snap Hook

- ✗ Snap hooks should be of the self-locking type
- ✗ No hook or eye distortion (twists, bends or elongation)
- ✗ Latch/keeper should seat into the nose w/o binding
- ✗ Latch/keeper should not be distorted or obstructed
- ✗ Overall deterioration/Excessive wear
- ✗ Modifications by the user
- ✗ Rust/pitting/corrosion
- ✗ No cracks
- ✗ No excessive wear
- ✗ No missing parts
- ✗ No rough or sharp edges

Snap Hook Locking Mechanism

- ✗ Disengage locking mechanism and open keeper (keeper should open freely)
- ✗ Disengage locking mechanism and release (locking mechanism should return to engaged position).

Snap Hook Keeper

- ✗ Check keeper spring action by opening the keeper and releasing. (Keeper should return to closed position without hanging up it should not close slowly.)
- ✗ Push on keeper without engaging locking mechanism (keeper should not open)
- ✗ Check to see the keeper is seated firmly on the snap hook nose – there should be no side play. (lateral movement)

Inspection Checklist – Fall Protection Equipment

Wire Rope

Description:	Model #:
Serial #:	Date of Manufacture:
Inspector:	Date Inspected:
Inspector Signature:	

✘ **FAIL:** Initial _____
REMOVE FROM SERVICE

✔ **PASS:** Initial _____
RETURN TO SERVICE

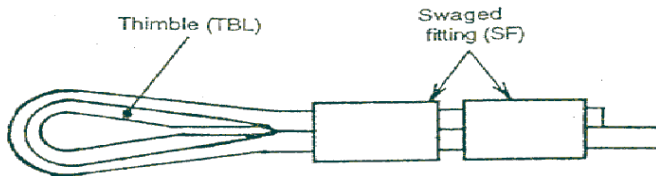

Figure 6a
Return Eye

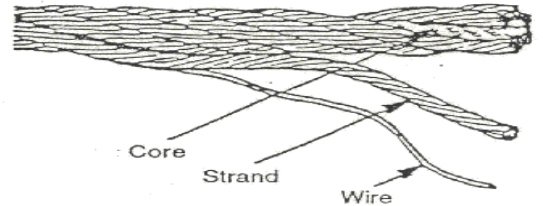

Figure 14e
Wire Rope Composition

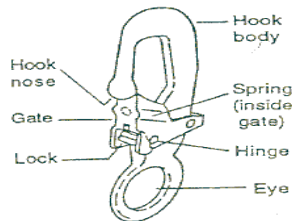

Figure 1n
Snaphook, Self-locking

ITEM #	DESCRIPTION – WIRE ROPE	FAIL ✘	PASS ✔	COMMENTS
	Broken Wires			
	Rust/Corrosion/Pitting			
	Deformations			
	Heat Damage			
	Fittings/Thimbles			
	Splices			
	Labeling (tags)			
	SNAPHOOK			
	Hook Body			
	Hook Nose			
	Gate (keeper)			
	Lock			
	Eye			
	Hinge			
	Spring (inside gate)			

Fall Limiters - Inspection

Retractable Lanyard (Housing/Cover Field Removable) Inspection – Guidelines

Self Retracting Lanyard - Complete w/ Webbing Lifeline

This type of SRL is usually 8' to 10' in length and the housing/cover is not permanently affixed to the unit.

When inspecting a self retracting lanyard be sure to pull out **all** the lifeline material. Lifeline material must be inspected end to end.

Test methods employed will be:

- 1.) Lanyard Retraction & Tension Test: tests the lifelines tension & ability to retract
- 2.) Braking Test: tests the braking mechanism is working and engaging.

Visual and Touch Inspection

✓ Pass

✗ Fail Criteria

- ✗ Check load impact indicator* for activation (if retractable is equipped with one)
- ✗ Loose fasteners
- ✗ Physical damage or missing parts
- ✗ Cracks or wear
- ✗ Check all connecting areas-no deformations allowed
- ✗ Corrosion
- ✗ Overall deterioration
- ✗ Modifications by user
- ✗ Bent, cracked, distorted, worn or malfunctioning parts
- ✗ Inspect lifeline for cuts, burns, corrosion, kinks, frays or worn areas
- ✗ Inspect lifeline sewing for loose, broken or damaged stitches
- ✗ Inspect lifeline for discoloration, brittleness, melted fibers, shiny/hard spots
- ✗ Inspect housing inside and out for deformations, cracks, physical damage
- ✗ ✓ Check for paint, dirt, grease or other materials (contaminants) Remove contaminants as per manufacturers instructions.

Note: The load impact indicator* can be a fold sewn into the webbing lifeline above the snap hook. A warning flag is included and will be exposed should the lifeline be subjected to fall arresting forces.

Material required to conduct tests.

- 1.) Anchor point (ie: tripod or similar device)
- 2.) Self Retracting Lifeline

Retractable Lanyard (Housing/Cover Field Removable) Inspection – Guidelines

Lanyard Retraction & Tension Test:

The purpose of the lanyard retraction & tension test is to ensure the lifeline is retracting smoothly into and out of the housing.

STEPS

- 1.) Mount self retracting lanyard on anchorage point
- 2.) Pull out 50% of the lifeline length
- 3.) Maintain a light tension on the lifeline
- 4.) Allow lifeline to retract back into housing. (Always maintain light tension when lifeline is retracting.)

Note: If lifeline does not pull out smoothly or sticks when retracting, pull all of the lifeline out of the housing and allow it to retract slowly under tension. Then repeat the above test.

Result – The lifeline should pull out freely and retract all the way back into the unit. Remove from service if device does not pass this test.

Braking Test

The purpose of the braking test is to ensure that the retractable's braking mechanism is working and engaging.

STEPS

- 1.) Mount self retracting lifeline on anchorage point
- 2.) Grasp lifeline and apply a sharp steady pull downward until brakes engage
- 3.) Keep tension on lifeline until brakes are fully engaged
- 4.) Release tension
- 5.) Allow lifeline to retract into housing under light tension

Result – Brakes should engage. There should be no slippage of the lifeline while the brakes are engaged. Once tension is released, the brakes should disengage and the unit should return to retractable mode. Remove from service if device does not pass this test.

Retractable Lanyard (Housing/Cover Field Removable) Inspection – Guidelines

Snap Hooks

Snap hooks should be of the self-locking type. Snap hooks are generally proof tested to 3,600 lbs. and have minimum tensile strength of 5,000lbs.

Visual and Manual Inspection

✓ Pass

✗ Fail Criteria

Snap Hook

- ✗ Snap hooks should be of the self-locking type
- ✗ No hook or eye distortion (twists, bends or elongation)
- ✗ Latch/keeper should seat into the nose w/o binding
- ✗ Latch/keeper should not be distorted or obstructed
- ✗ Overall deterioration/Excessive wear
- ✗ Modifications by the user
- ✗ Rust/pitting/corrosion
- ✗ No cracks
- ✗ No excessive wear
- ✗ No missing parts
- ✗ No rough or sharp edges

Snap Hook Locking Mechanism

- ✗ Disengage locking mechanism and open keeper (keeper should open freely)
- ✗ Disengage locking mechanism and release (locking mechanism should return to engaged position).

Snap Hook Keeper

- ✗ Check keeper spring action by opening the keeper and releasing. (Keeper should return to closed position without hanging up it should not close slowly.)
- ✗ Push on keeper without engaging locking mechanism (keeper should not open)
- ✗ Check to see the keeper is seated firmly on the snap hook nose – there should be no side play. (lateral movement)

Swivel Connectors

- ✗ Swivel connections must not be loose and be allowed to swivel freely as designed
- ✗ No physical damage, cracks, bends, deformations

Retractable Lanyard (Housing/Cover Field Removable) Inspection – Guidelines

Tagging System

Every retractable should have a identification system, with details such as model, date of manufacture, name of manufacturer, limitations and warnings.

- ✘ Check tag for date of manufacture and remove from service if past adopted service life policy
- ✘ If tagging system is missing or not legible remove retractable from service.

Cleaning and Storage

Periodically clean the exterior of the device and wipe the lifeline using a damp cloth and mild detergent. Towel dry.

Store in a clean dry location, free of exposure to fumes, heat, direct ultra violet light, sunlight and corrosive elements.

The lifeline should be fully retracted into the unit when not in use. Failure to do so on some models may cause premature weakening of the mainspring resulting in a loss of lifeline retraction.

Inspection Checklist – Fall Protection Equipment Retractable Lanyard (Housing/Cover Field Removable)

Description:	Model #:
Serial #:	Date of Manufacture:
Inspector:	Date Inspected:
Inspector Signature:	

✘ **FAIL:** Initial _____

REMOVE FROM SERVICE

✓ **PASS:** Initial _____

RETURN TO SERVICE

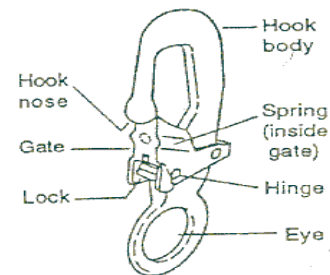
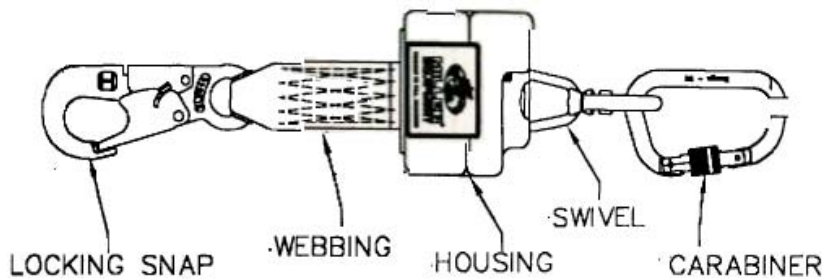

Figure 1n
Snaphook, Self-locking

ITEM #	DESCRIPTION –	FAIL ✘	PASS ✔	COMMENTS
	Load Impact Indicator			
	Webbing			
	Stitching			
	Labeling (tags)			
	Deformation			
	Housing			
	SNAPHOOK			If applicable see carabiners
	Swivel Connectors			
	Hook Body			
	Hook Nose			
	Gate (keeper)			
	Lock			
	Eye			
	Hinge			
	Spring (inside gate)			
	Tests			
	Retraction & Tension			
	Braking Test			

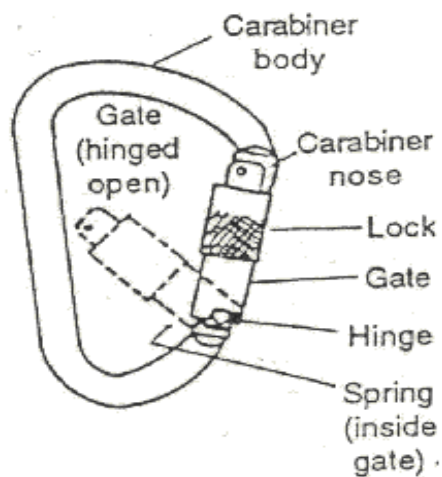

Figure 1q
Carabiner, Self-locking

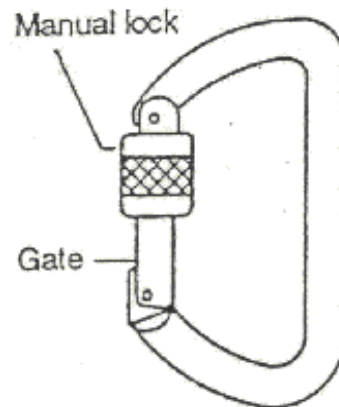

Figure 1r
Carabiner Manual-locking

Retractable Lanyard (Housing/Cover Field Removable)

ITEM #	DESCRIPTION	FAIL	PASS	COMMENTS
	Carabiner	✘	✔	
	Carabiner Body			
	Carabiner Nose			
	Gate (hinged open)			
	Lock			
	Gate			
	Hinge			
	Spring (inside gate)			
	Manual Lock			

Retractable Lanyard (Housing/Cover Non Field Removable) Inspection – Guidelines

Self Retracting Lanyard – Webbing or Wire Rope Lifeline

This type of SRL is usually 20' in length or greater. The housing/cover will be non field removable and will require special tools to open. **Do not open unit unless you have been authorized and trained by the manufacturer.**

Note: Manufacturers may require that the unit be sent in for an annual inspection – check owners manual for details.

When inspecting a self retracting lanyard be sure to pull out **all** the lifeline material. Lifeline material must be inspected end to end.

Test methods employed will be:

- 1.) Lanyard Retraction & Tension Test: tests the lifelines tension & ability to retract
- 2.) Braking Test: tests the braking mechanism is working and engaging.

Visual and Touch Inspection

✔ Pass

✘ Fail Criteria

Housing/Cover – Inspect For

- ✘ Ensure casing bolts are tight
- ✘ Loose fasteners
- ✘ Missing parts
- ✘ Cracks or wear
- ✘ Check all connecting areas-no deformations allowed
- ✘ Corrosion

- ✘ Overall deterioration
- ✘ Modifications by user
- ✘ Physical damage
- ✘ Bent, cracked, distorted, worn or malfunctioning parts

Load Impact Indicator

- ✘ Check load impact indicator* for activation (if retractable is equipped with one)

Note: The load impact indicator* may be located in the lanyard above the snap hook. A label will be exposed when subjected to fall arresting forces. The load impact indicator may also be located on the snaphook or the unit itself. Check manufacturers operation and installation instructions for exact location.

Retractable Lanyard (Housing/Cover Non Field Removable) Inspection – Guidelines

Inspection of Webbing for Retractable Lanyard

Webbing

Grasp the webbing with your hands and bend the webbing, checking both sides. This creates surface tension making damaged fibers or cuts easier to see. Webbing damage may not show up through a sight (visual) inspection only – manual (touch) the lanyard is equally important.

Visual and Touch Inspection

✓ Pass

✘ Fail Criteria

- ✘ Cuts, nicks or tears
- ✘ Broken fibers/cracks
- ✘ Overall deterioration
- ✘ Modifications by user
- ✘ Fraying/Abrasions
- ✘ ✓ Discoloration of material
- ✘ Hard or shiny spots
- ✘ Change in core size
- ✓ Mildew
- ✘ Undue Stretching
- ✘ Burnt, charred or melted fibers
- ✘ ✓ Material marked w/permanent marker
- ✘ Excessive hardness or brittleness
- ✘ Knots in lanyard

Dependant on cause of discoloration

Indicates heat damage

Indicates possible fall

Clean lanyard

Indicates possible fall

Indicates heat damage

Check w/manufacturer

Indicates heat or uv damage

Retractable Lanyard (Housing/Cover Non Field Removable) Inspection – Guidelines

Wire Rope

Grasp the steel lanyard with your hands and rotate the lanyard, checking both sides. Watch for unusual wearing patterns on the wire. Broken strands or wires will separate from the body of the lanyard. **To avoid hand injury always wear protective gloves when inspecting a wire rope lanyard.**

Note: Unlike rigging inspection standards, wire rope used for the purpose of fall protection is not allowed any broken wires or strands.

Visual and Touch Inspection

✓ Pass

✗ Fail Criteria

- ✗ Cuts, frayed areas
- ✗ Worn or broken strands/wires
- ✗ Overall deterioration/Excessive outside wear
- ✗ Modifications by the user
- ✗ Rust/pitting/corrosion
- ✗ Crushed/jammed or flattened strands
- ✗ Bulges in rope
- ✗ Gaps between strands
- ✗ Heat damage, torch burns or electric arc strikes
- ✗ Kinks, bird-caging
- ✗ Core protrusion
- ✗ Do not use frozen rope

Fittings

- ✗ Wear or Cracks
- ✗ Corrosion or Pitting
- ✗ Deformation/Bends
- ✗ Mismatched Parts or Modifications
- ✗ Obvious Damage

Splices

- ✗ Worn or broken wires
- ✗ Crushed/jammed or flattened strands
- ✗ Corrosion

Material required to conduct tests.

- 1.) Anchor point (ie: tripod or similar device)
- 2.) Retractable Lifeline

Retractable Lanyard (Housing/Cover Non Field Removable) Inspection – Guidelines

Lanyard Retraction & Tension Test:

Do not pull lifeline out of the housing or let it retract while the unit is laying flat. Always inspect and operate the unit in a mounted position.

The purpose of the lanyard retraction & tension test is to ensure the lifeline is retracting smoothly into and out of the housing.

STEPS

- 1.) Mount retractable on anchorage point
- 2.) Pull out 50% of the lifeline length
- 3.) Maintain a light tension on the lifeline (approx. 1 lb. (0.45kg))
- 4.) Allow lifeline to retract back into housing. (Always maintain light tension when lifeline is retracting.)
- 5.) Repeat Steps 2 to 4 this time pulling out 100% of lifeline length

Do Not allow lifeline to retract into housing uncontrolled – this could result in injury and damage to the unit.

Note: If lifeline does not pull out smoothly or sticks when retracting, pull the entire lifeline out of the housing and allow it to retract slowly under tension. Then repeat the above test.

Result – The lifeline should pull out freely and retract all the way back into the unit. Remove from service if device does not pass this test.

Braking Test

The purpose of the braking test is to ensure that the retractable's braking mechanism is working and engaging.

STEPS

- 1.) Mount retractable on anchorage point
- 2.) Grasp lifeline and apply a sharp steady pull downward until brakes engage
- 3.) Keep tension on lifeline until brakes are fully engaged
- 4.) Release tension
- 5.) Allow lifeline to retract into housing under light tension

Result – Brakes should engage. There should be no slippage of the lifeline while the brakes are engaged. Once tension is released, the brakes should disengage and the unit should return to retractable mode. Remove from service if device does not pass this test.

Retractable Lanyard (Housing/Cover Non Field Removable) Inspection – Guidelines

Snap Hooks

Snap hooks should be of the self-locking type. Snap hooks are generally proof tested to 3,600 lbs. and have minimum tensile strength of 5,000lbs.

Visual and Manual Inspection

✓ Pass

✗ Fail Criteria

Snap Hook

- ✗ Snap hooks should be of the self-locking type
- ✗ No hook or eye distortion (twists, bends or elongation)
- ✗ Latch/keeper should seat into the nose w/o binding
- ✗ Latch/keeper should not be distorted or obstructed
- ✗ Overall deterioration/Excessive wear
- ✗ Modifications by the user
- ✗ Rust/pitting/corrosion
- ✗ No cracks
- ✗ No excessive wear
- ✗ No missing parts
- ✗ No rough or sharp edges

Snap Hook Locking Mechanism

- ✗ Disengage locking mechanism and open keeper (keeper should open freely)
- ✗ Disengage locking mechanism and release (locking mechanism should return to engaged position).

Snap Hook Keeper

- ✗ Check keeper spring action by opening the keeper and releasing. (Keeper should return to closed position without hanging up it should not close slowly.)
- ✗ Push on keeper without engaging locking mechanism (keeper should not open)
- ✗ Check to see the keeper is seated firmly on the snap hook nose – there should be no side play. (lateral movement)

Swivel Connectors

- ✗ Swivel connections must not be loose and be allowed to swivel freely as designed
- ✗ No physical damage, cracks, bends, deformations

Retractable Lanyard (Housing/Cover Non Field Removable) Inspection – Guidelines

Tagging System

Every retractable should have a identification system, with details such as model, date of manufacture, name of manufacturer, limitations and warnings.

- ✘ Check tag for date of manufacture and remove from service if past adopted service life policy
- ✘ If tagging system is missing or not legible remove retractable from service.

Cleaning And Storage

Periodically clean the exterior of the device and wipe the lifeline using a damp cloth and mild detergent. Towel dry.

Store in a clean dry location, free of exposure to fumes, heat, direct ultra violet light, sunlight and corrosive elements.

The lifeline should be fully retracted into the unit when not in use. Failure to do so on some models may cause premature weakening of the mainspring resulting in a loss of lifeline retraction.

Inspection Checklist – Fall Protection Equipment

Retractable Lanyard (Housing/Cover Non Field Removable)

Description:	Model #:
Serial #:	Date of Manufacture:
Inspector:	Date Inspected:
Inspector Signature:	

✘ **FAIL:** Initial _____

**REMOVE FROM SERVICE
REPAIR**

✔ **PASS:** Initial _____

RETURN TO SERVICE

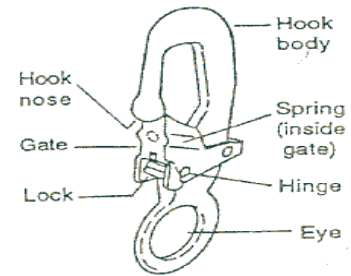
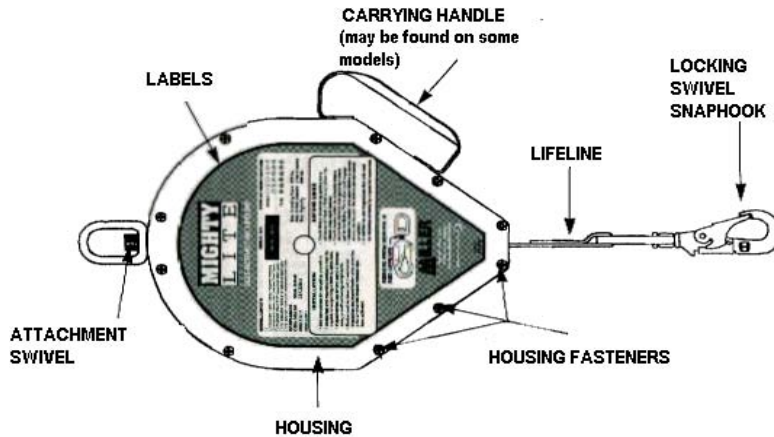

Figure 1n
Snaphook, Self-locking

ITEM #	DESCRIPTION – GENERAL	FAIL ✘	PASS ✔	COMMENTS
	Load Impact Indicator			
	Housing cover			
	Deformation			
	Labeling (tags)			
	SNAPHOOK			If applicable see carabiners
	Swivel Connectors			
	Hook Body			
	Hook Nose			
	Gate (keeper)			
	Lock			
	Eye			
	Hinge			
	Spring (inside gate)			
	Lifeline – Web			
	Webbing			
	Stitching			

Retractable Lanyard (Housing/Cover Non Field Removable)

ITEM #	DESCRIPTION –	FAIL	PASS	COMMENTS
	LIFELINE – WIRE ROPE	✘	✔	
	Broken Wires			
	Rust/Corrosion/Pitting			
	Deformations			
	Heat Damage			
	Fittings/Thimbles			
	Splices			
	Tests			
	Retraction & Tension			
	Braking Test			

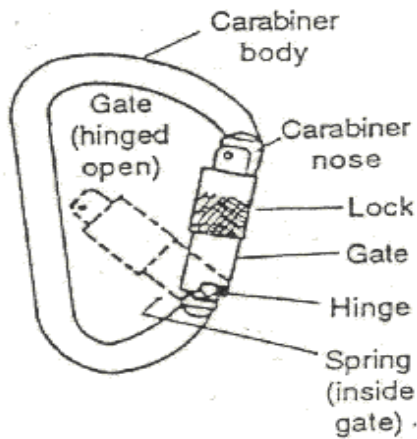

Figure 1q
Carabiner, Self-locking

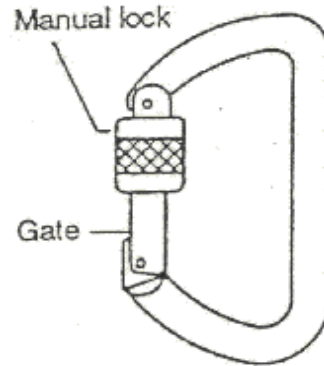

Figure 1r
Carabiner Manual-locking

Retractable Lanyard (Housing/Cover Non Field Removable)

ITEM #	DESCRIPTION	FAIL	PASS	COMMENTS
	Carabiner	✘	✔	
	Carabiner Body			
	Carabiner Nose			
	Gate (hinged open)			
	Lock			
	Gate			
	Hinge			
	Spring (inside gate)			
	Manual Lock			

Self Retracting Lifeline Complete w/ Recovery Inspection – Guidelines

Self Retracting Lifeline Complete w/ Recovery.

This type of SRL will have the ability of retrieval via a winching mechanism. The housing/cover will be non-field removable and require special tools to open. **Do not open unit unless you have been authorized and trained by the manufacturer.**

Note: Manufacturers may require that the unit be sent in for an annual inspection – check owners manual for details.

When inspecting a self retracting lanyard be sure to pull out **all** the lifeline material. Lifeline material must be inspected end to end.

Test methods employed will be:

- 1.) Lanyard Retraction & Tension Test: tests the lifelines tension & ability to retract
- 2.) Braking Test: tests the braking mechanism is working and engaging.
 - 1.) Retrieval Mode: tests the units retrieval mechanism

Visual and Touch Inspection

✓ Pass

✗ Fail Criteria

Housing/Cover – Inspect For

- ✗ Ensure casing bolts are tight
- ✗ Loose fasteners
- ✗ Missing parts
- ✗ Cracks or wear
- ✗ Check all connecting areas-no deformations allowed
- ✗ Corrosion
- ✗ Overall deterioration
- ✗ Modifications by user
- ✗ Physical damage
- ✗ Bent, cracked, distorted, worn or malfunctioning parts

Load Impact Indicator

- ✗ Check load impact indicator* for activation (if retractable is equipped with one)

Note: The load impact indicator* may be located in the lanyard above the snap hook. A label will be exposed when subjected to fall arresting forces. The load impact indicator may also be located on the snaphook or the unit itself. Check manufacturers operation and installation instructions for exact location.

Self Retracting Lifeline Complete w/ Recovery Inspection – Guidelines

Wire Rope

Grasp the steel lanyard with your hands and rotate the lanyard, checking both sides. Watch for unusual wearing patterns on the wire. Broken strands or wires will separate from the body of the lanyard. **To avoid hand injury always wear protective gloves when inspecting a wire rope lanyard.**

Note: Unlike rigging inspection standards, wire rope used for the purpose of fall protection is not allowed any broken wires or strands.

Visual and Touch Inspection

✓ Pass

✗ Fail Criteria

- ✗ Cuts, frayed areas
- ✗ Worn or broken strands/wires
- ✗ Overall deterioration/Excessive outside wear
- ✗ Modifications by the user
- ✗ Rust/pitting/corrosion
- ✗ Crushed/jammed or flattened strands
- ✗ Bulges in rope
- ✗ Gaps between strands
- ✗ Heat damage, torch burns or electric arc strikes
- ✗ Kinks, bird-caging
- ✗ Core protrusion
- ✗ Do not use frozen rope

Fittings

- ✗ Wear or Cracks
- ✗ Corrosion or Pitting
- ✗ Deformation/Bends
- ✗ Mismatched Parts or Modifications
- ✗ Obvious Damage

Splices

- ✗ Worn or broken wires
- ✗ Crushed/jammed or flattened strands
- ✗ Corrosion

Material required to conduct tests.

- 1.) Anchor point (ie: tripod or similar device)
- 2.) Retractable Lifeline

Self Retracting Lifeline Complete w/ Recovery Inspection – Guidelines

Lanyard Retraction & Tension Test:

Do not pull lifeline out of the housing or let it retract while the unit is laying flat. Always inspect and operate the unit in a mounted position.

The purpose of the lanyard retraction & tension test is to ensure the lifeline is retracting smoothly into and out of the housing.

STEPS

- 1.) Mount retractable on anchorage point
- 2.) Pull out 50% of the lifeline length
- 3.) Maintain a light tension on the lifeline (approx. 1 lb. (0.45kg))
- 4.) Allow lifeline to retract back into housing. (Always maintain light tension when lifeline is retracting.)
- 5.) Repeat Steps 2 to 4 this time pulling out 100% of lifeline length

Do Not allow lifeline to retract into housing uncontrolled – this could result in injury and damage to the unit.

Note: If lifeline does not pull out smoothly or sticks when retracting, pull all of the lifeline out of the housing and allow it to retract slowly under tension. Then repeat the above test.

Result – The lifeline should pull out freely and retract all the way back into the unit. Remove from service if device does not pass this test.

Braking Test

The purpose of the braking test is to ensure that the retractable's braking mechanism is working and engaging.

STEPS

- 1.) Mount retractable on anchorage point
- 2.) Grasp lifeline and apply a sharp steady pull downward until brakes engage
- 3.) Keep tension on lifeline until brakes are fully engaged
- 4.) Release tension
- 5.) Allow lifeline to retract into housing under light tension

Result – Brakes should engage. There should be no slippage of the lifeline while the brakes are engaged. Once tension is released, the brakes should disengage and the unit should return to retractable mode. Remove from service if device does not pass this test.

Self Retracting Lifeline Complete w/ Recovery Inspection – Guidelines

Retrieval Mode Test:

The purpose of the retrieval mode test is to ensure that the retractable's retrieval mechanism is working and engaging.

Note: some units when in the lowering position will require a minimum of 75lbs.

STEPS

- 1.) Mount retractable on anchorage point
- 2.) Grasp lifeline & pull out several feet of lifeline
- 3.) Hold line in position, maintaining light tension on the line
- 4.) Without engaging retrieval mode attempt to retrieve line
Result –line should not retrieve unless unit has been activated.
- 5.) Now engage retrieval mode
- 6.) Keeping light tension on the line – use the winch handle to retrieve the line into the device.

Result – Brakes should engage. There should be no slippage of the lifeline while the brakes are engaged. Once tension is released, the brakes should disengage and the unit should return to retractable mode. Remove from service if device does not pass this test.

Snap Hooks

Snap hooks should be of the self-locking type. Snap hooks are generally proof tested to 3,600 lbs. and have minimum tensile strength of 5,000lbs.

Visual and Manual Inspection

✓ Pass

✗ Fail Criteria

Snap Hook

- ✗ Snap hooks should be of the self-locking type
- ✗ No hook or eye distortion (twists, bends or elongation)
- ✗ Latch/keeper should seat into the nose w/o binding
- ✗ Latch/keeper should not be distorted or obstructed
- ✗ Overall deterioration/Excessive wear
- ✗ Modifications by the user
- ✗ Rust/pitting/corrosion
- ✗ No cracks
- ✗ No excessive wear
- ✗ No missing parts
- ✗ No rough or sharp edges

Self Retracting Lifeline Complete w/ Recovery Inspection – Guidelines

Snap Hook Locking Mechanism

- ✘ Disengage locking mechanism and open keeper (keeper should open freely)
- ✘ Disengage locking mechanism and release (locking mechanism should return to engaged position.)

Snap Hook Keeper

- ✘ Check keeper spring action by opening the keeper and releasing. (Keeper should return to closed position without hanging up it should not close slowly.)
- ✘ Push on keeper without engaging locking mechanism (keeper should not open)
- ✘ Check to see the keeper is seated firmly on the snap hook nose – there should be no side play. (lateral movement)

Swivel Connectors

- ✘ Swivel connections must not be loose and be allowed to swivel freely as designed
- ✘ No physical damage, cracks, bends, deformations

Tagging System

Every retractable should have a identification system, with details such as model, date of manufacture, name of manufacturer, limitations and warnings.

- ✘ Check tag for date of manufacture and remove from service if past adopted service life policy
- ✘ If tagging system is missing or not legible remove retractable from service.

Cleaning and Storage

Periodically clean the exterior of the device and wipe the lifeline using a damp cloth and mild detergent. Towel dry.

Store in a clean dry location, free of exposure to fumes, heat, direct ultra violet light, sunlight and corrosive elements.

The lifeline should be fully retracted into the unit when not in use. Failure to do so on some models may cause premature weakening of the mainspring resulting in a loss of lifeline retraction.

Inspection Checklist – Fall Protection Equipment

Self Retracting Lifeline Complete w/ Recovery

Description:	Model #:
Serial #:	Date of Manufacture:
Inspector:	Date Inspected:
Inspector Signature:	

✘ **FAIL:** Initial _____
REMOVE FROM SERVICE
REPAIR

✔ **PASS:** Initial _____
RETURN TO SERVICE

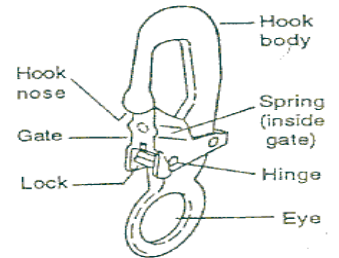
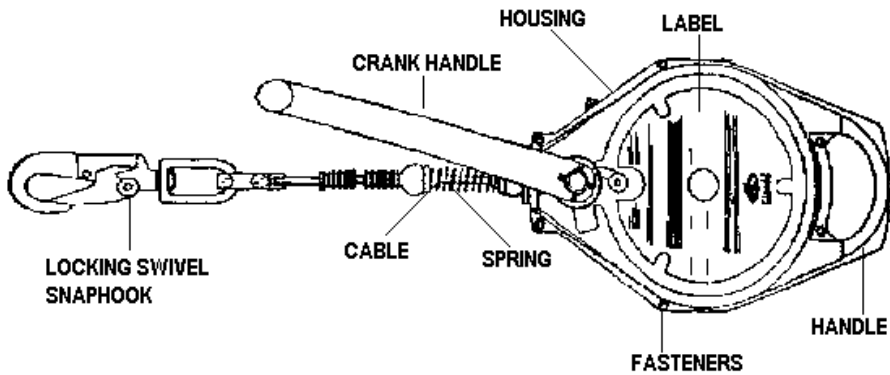

Figure 1n
Snaphook, Self-locking

ITEM #	DESCRIPTION – GENERAL	FAIL ✘	PASS ✔	COMMENTS
	Load Impact Indicator			
	Housing cover			
	Deformation			
	Labeling (tags)			
	SNAPHOOK			(if applicable see Carabiners)
	Swivel Connectors			
	Hook Body			
	Hook Nose			
	Gate (keeper)			
	Lock			
	Eye			
	Hinge			
	Spring (inside gate)			
	Lifeline – Web			
	Webbing			
	Stitching			

Self Retracting Lifeline c/w Recovery

ITEM #	DESCRIPTION – LIFELINE – WIRE ROPE	FAIL ✘	PASS ✔	COMMENTS
	Broken Wires			
	Rust/Corrosion/Pitting			
	Deformations			
	Heat Damage			
	Fittings/Thimbles			
	Splices			
	Tests			
	Retraction & Tension Test			
	Braking Test			
	Retrieval Mode Test			

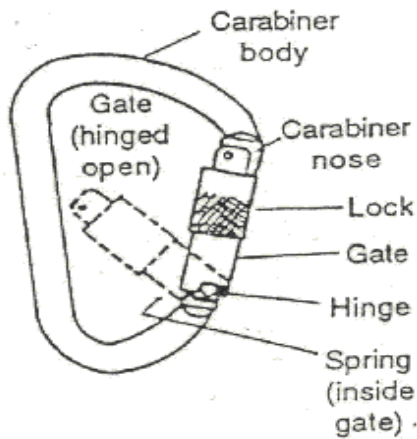

Figure 1q
Carabiner, Self-locking

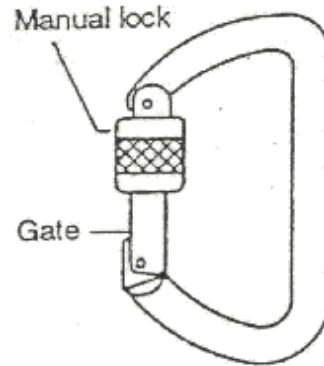

Figure 1r
Carabiner Manual-locking

Self Retracting Lifeline Complete w/ Recovery

ITEM #	DESCRIPTION CARABINER	FAIL ✘	PASS ✔	COMMENTS
	Carabiner Body			
	Carabiner Nose			
	Gate (hinged open)			
	Lock			
	Gate			
	Hinge			
	Spring (inside gate)			
	Manual Lock			